

EYEZONE B1080Play

User Manual



Feb 24, 11

CONTENTS

1. Package Contents.....	1
2. Introduction.....	1
3. Features.....	1
4. Hardware Overview.....	2
5. Remote Control.....	3
6. Using the B1080Play.....	4
6.1 Start the B1080Play.....	4
6.2 Home Menu.....	4
6.3 Movie Playback.....	5
6.4 Photo View.....	6
6.5 Music Playback.....	7
6.6 File Interface.....	7
6.7 Copy File.....	8
6.8 Delete File.....	9
7. Setting Up.....	10
7.1 Display.....	11
7.2 Language.....	11
7.3 Photo Setup.....	12
7.4 Movie Setup.....	12
7.5 Music Setup.....	13
7.6 Default.....	13
7.7 About.....	13
8. Troubleshooting.....	14

1. PACKAGE CONTENTS

1. B1080Play
2. Remote Control
3. User Manual
4. Power Adapter (DC5V, 2A)
5. Component Video Cable
6. Audio Cable



B1080PB



Remote Control



User Manual



Power Adapter
(DC5V, 2A)



Component
Video Cable



Audio Cable

2. INTRODUCTION

The Eyezone B1080Play is a high-performance and low-cost digital signage player that allows you to play advertising contents in 1080P HD. No software is required, simply insert the SD(HC) card or USB flash driver with media files and it will play the media files automatically. The B1080Play offers HDMI, Component Video and Video output to match your display's input.

The B1080Play is an ideal for advertising, retail displays, digital poster, museum exhibits and other applications.

3. FEATURES

- Supports multiple file formats: Video, Photo and Music.
- Supports HDMI, Component Video and Video (with audio) outputs.
- Resolution:
 - HDMI: up to 1080p.
 - YPbPr: up to 1080i
- Supports SD(HC) card and USB flash driver.
- Supports Auto-Play function.
- Play photos as a slideshow with background music
- Multi-Language OSD: English, Chinese, German, French, Spanish, Italian, Portuguese, Netherlands and Russian.
- Dimensions (L/ W/ H): 149x95x25.5 mm.

4. HARDWARE OVERVIEW

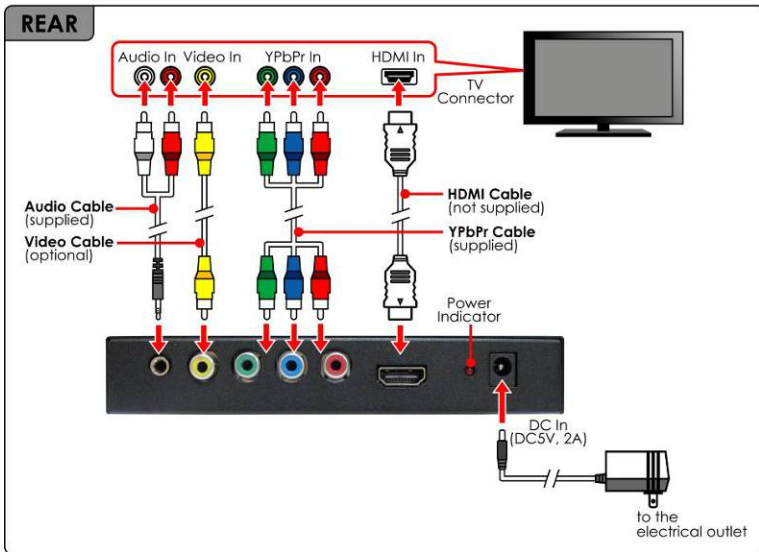
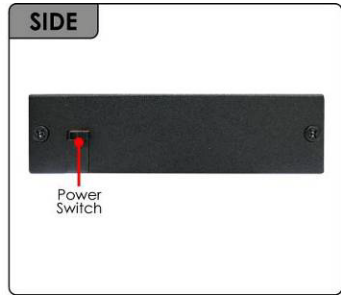
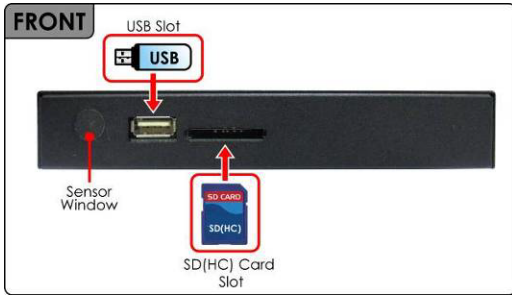

- **USB Slot:** Insert the USB flash driver.
- **SD Card Slot:** Insert the SD memory card.
- **Power Switch:** Toggle between main power on & off.
- **Audio Output:** Connect to audio input on TV or external speakers.
- **Video Output:** Connect to video input on TV.
- **Component Video Output:** Connect to component video input (YPbPr) on TV.
- **HDMI Output:** Connect to HDMI input on TV.
- **Power Indicator**
- **DC Input:** Connect the supplied power adapter. (DC5V / 2A)

5. REMOTE CONTROL

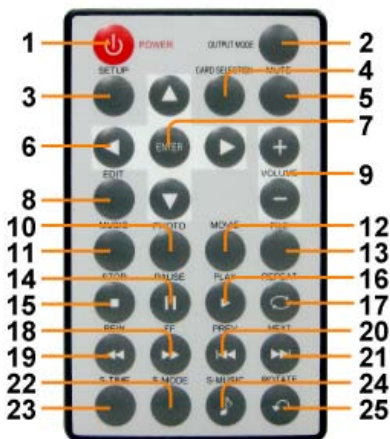

- 1 Power on/ off
- 2 Change the output mode
- 3 Open the setting menu
- 4 Back to previous screen
- 5 Storage device selection (in home menu)
- 6 Mute sound
- 7 Move the cursor
- 8 Confirm/ enter/ playback
- 9 Open the Copy/ Delete menu (in file list)
- 10 Volume up/ down
- 11 Enter into the photo file list.
- 12 Enter into the music file list.
- 13 Enter into the video file list.
- 14 Enter into the file list. (list all the media files)
- 15 Pause/ resume playback
- 16 Stop playback
- 17 Play the selected file
- 18 Select the repeat mode
- 19 Forward videos or music
- 20 Rewind videos or music
- 21 Skip to the previous file
- 22 Skip to the next file
- 23 Change the display mode when playing video
- 24 Open the time search bar when playing video
- 25 Enable/ disable background music
- 26 Rotate the photo
- 27
- 28
- 29
- 30
- 31
- 32
- 33
- 34
- 35
- 36
- 37
- 38
- 39
- 40
- 41
- 42
- 43
- 44
- 45
- 46
- 47
- 48
- 49
- 50
- 51
- 52
- 53
- 54
- 55
- 56
- 57
- 58
- 59
- 60
- 61
- 62
- 63
- 64
- 65
- 66
- 67
- 68
- 69
- 70
- 71
- 72
- 73
- 74
- 75
- 76
- 77
- 78
- 79
- 80
- 81
- 82
- 83
- 84
- 85
- 86
- 87
- 88
- 89
- 90
- 91
- 92
- 93
- 94
- 95
- 96
- 97
- 98
- 99
- 100

6. USING THE B1080Play

6.1 Start the B1080Play

Step1: Using the HDMI or component video cable to connect between B1080Play and TV.

Step2: Insert the SD memory card or USB flash driver with media files.

Step3: Connect the power adapter and turn on the power switch, then the B1080Play will power on automatically.

NOTE: After boot, the B1080Play will play the media files automatically, you can press the **STOP** key, and press the **Card Selection** key to back to home menu.

- If the first file in the file list is video format, the B1080Play will play all the video files automatically.
- If the first file in the file list is picture format, the B1080Play will play all the picture files with background music automatically.
- If the first file in the file list is music format, the B1080Play will play all the music files automatically.

6.2 Home Menu

There are five icons (Movie, Photo, Music, File and Setting) in home menu. You can use the left or right key to select these options and press **ENTER** key to enter the option.

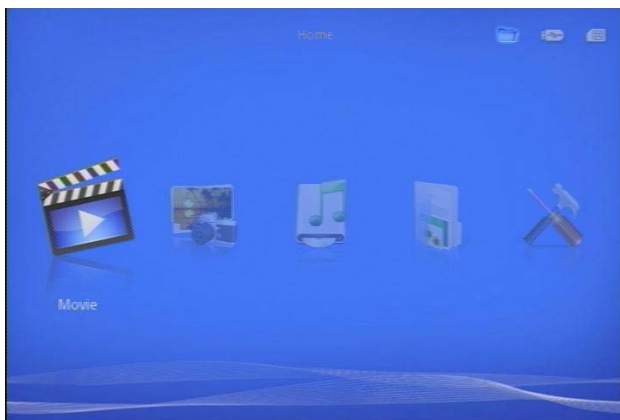

In the home menu, you can use the **Card Selection** key to select storage device (USB storage or SD card).



6.3 Movie Playback

Step1: Select the **Movie** icon and press **ENTER** key to enter the movie list.

Step2: Use the up or down key to select movie file and press **ENTER** key to playback.

Step3: Press **Stop** or **Card Selection** key to back to movie list when playing movie.

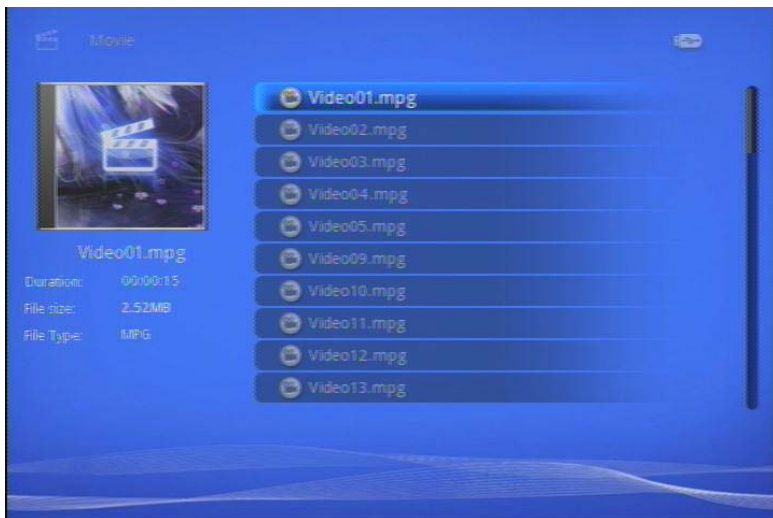

6.3.1 Movie Info Bar

Press the **Pause** key to open the info bar when playing movie. The info bar includes previous, fast rewind, play/ pause, subtitle, audio switch, zoom in (out), fast forward and next functions. You can use the left or right key to select and press **ENTER** key to enable.

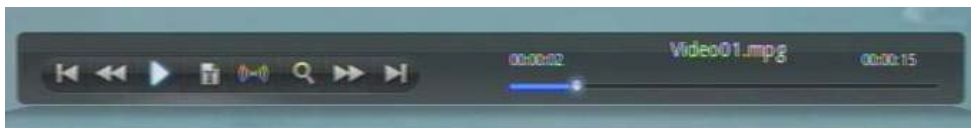

6.3.2 Time Search Bar

Press the **S-Time** key to open the time search bar when playing movie. You can use the up or down key to set the time and press **ENTER** key to enable.



6.3.3 Resume Playback

NOTE: The resume play function must be enabled (refer to section 7.4 Movie Setup).

If you try to open a video file that has been partially played before, and the following screen will appear.

Select **Y** to resume playback or select **X** to start playback from the beginning.

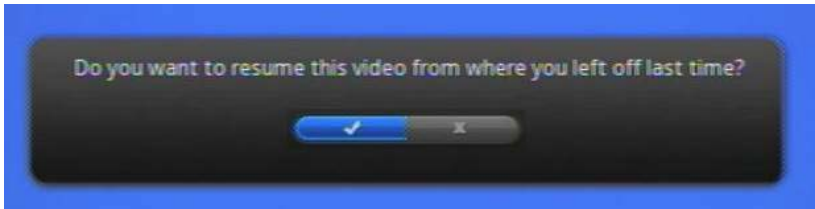

6.4 Photo View

Step1: Select the **Photo** icon and press **ENTER** key to enter the photo list.

Step2: Use the up or down key to select photo file and press **ENTER** key to view the selected photo.



6.4.1 Photo Info Bar

Press the **Pause** key to open the info bar when slideshow photos. The info bar includes previous, play/pause, rotate, zoom, background music, viewing mode and next functions. You can use the left or right key to select and press **ENTER** key to enable.



6.5 Music Playback

Step1: Select the **Music** icon and press **ENTER** key to enter the music list.

Step2: Use the up or down key to select music file and press **ENTER** key to playback.



6.5.1 Music Info Bar

The info bar includes previous, fast rewind, play/ pause, stop, play mode, repeat mode, fast forward and next functions. You can use the left or right key to select and press **ENTER** key to enable.

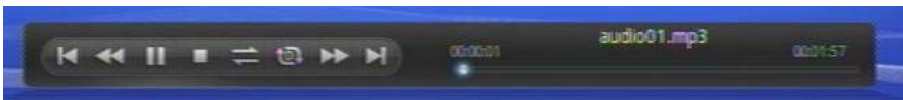

6.6 File Interface

Step1: Select the **File** icon and press **ENTER** key to enter the file interface.

Step2: The file interface will list all media file. You can use the up or down key to select media file and press the **ENTER** key to playback.

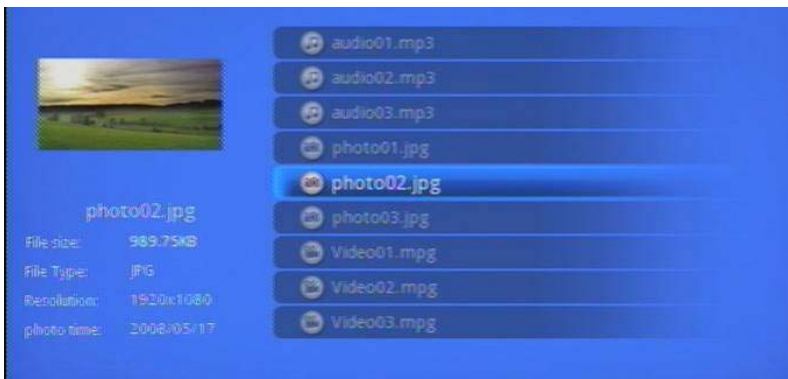

6.7 Copy File

Step1: Select one file or one folder in the file list, and press the **EDIT** key to open the Copy/ Delete menu.



Step2: Select **Copy** option and press **ENTER** key to enter into copy menu.



Step3: Use the up or down key to select target device, and press **ENTER** key to start copy.



Step4: After copy complete, the copy menu will display the “**copy complete**” message.

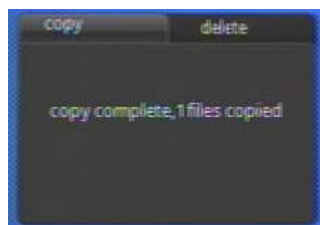

Step5: After complete, press the **Card Selection** key to exit copy menu.

6.8 Delete File

Step1: Select one file or one folder in the file list, and press the **EDIT** key to open the Copy/ Delete menu.

Step2: Select **Delete** option and press **ENTER** key to enter into delete menu.



Step3: Select the ✓ icon and press the **ENTER** key to start delete.



Step4: After delete complete, the delete menu will display the “delete complete” message.

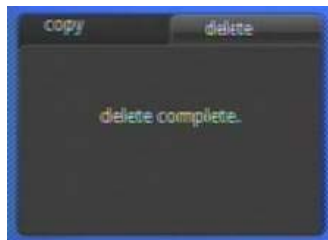

Step5: After complete, press the **Card Selection** key to exit delete menu.

7. SETTING UP

- In the home menu, select **Setting** icon and press **ENTER** key to enter into setting menu (you can also directly press the SETUP key to into setting menu).



- In the settings menu, you can use the up or down key to select options and press the **ENTER** key to enter sub-menu.



7.1 Display

- **Display:** The option is change the output mode and resolution (include NTSC, PAL, 480i, 480P, 576i, 576P, 720P, 1080i and 1080P), press **ENTER** key to enable.

- **TV Mode:** The option is TV screen proportional (include 4:3 and 16:9).



7.2 Language

Select the menu language (English/ Chinese/ German/ French/ Spanish/ Italian/ Portuguese, Netherlands/ Russian)

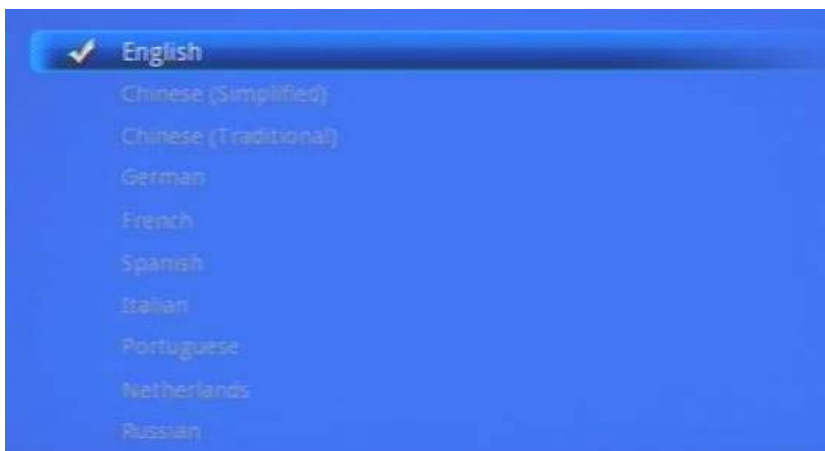

7.3 Photo Setup

- **View:** Set photo interface file display mode (Thumbnail and List).
- **Sorting:** Set photo file sort mode (by file name and by file date).
- **Directory:** Set the photo interface whether to display the folder.
- **Repeat:** Set the repeat mode (Repeat all, Repeat directory and Repeat off).
- **Cropping:** Set photo specifications mode (Smart crop, Stretch photo and Entire photo).
- **Slideshow duration:** Set the interval time of slideshow (3, 5, 10, 30 and 60 second and 5 minutes).
- **Transition effect:** Enable/ disable the transition effect.

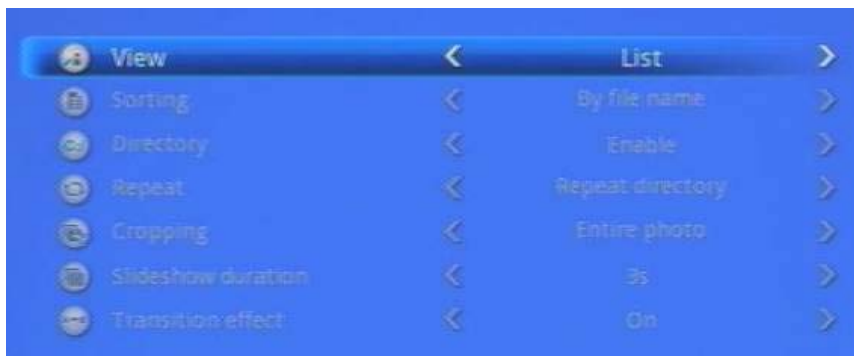

7.4 Movie Setup

- **View:** Set movie interface file display mode (Thumbnail and List).
- **Sorting:** Set movie file sort mode (by file name and by file date).
- **Directory:** Set the movie interface whether to display the folder.
- **Repeat:** Set the repeat mode (Repeat all, Repeat directory, Repeat movie and Repeat off).
- **Subtitle:** Set whether to automatically open the video subtitles.
- **Resume Play:** Enable/ disable the resume play function.
- **Digital Audio Output:** Set the digital audio output mode (SPDIF RAW/ SPDIF PCM).
- **List Mode Preview:** Enable/ disable the preview function.

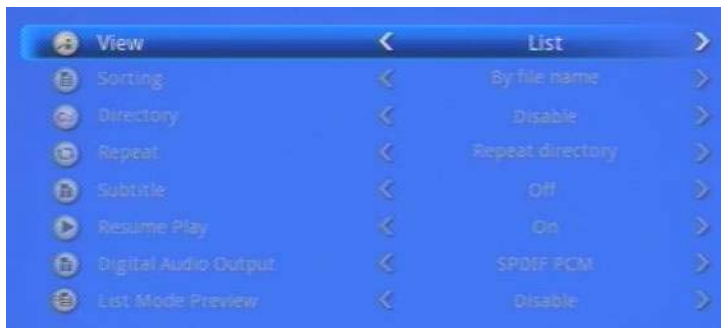

7.5 Music Setup

- **View:** Set music interface file display mode (Thumbnail and List).
- **Sorting:** Set music file sort mode (by file name and by file date).
- **Directory:** Set the music interface whether to display the folder.
- **Repeat:** Set the repeat mode (Repeat all, Repeat directory, Repeat song and Repeat off).
- **Lyrics:** Display the lyrics of the song.

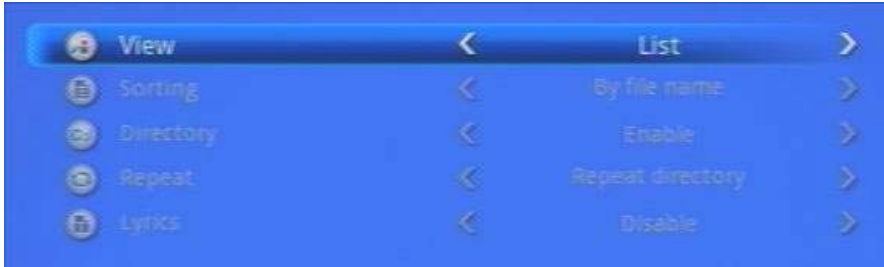

7.6 Default

Reset all settings to the default settings.



7.7 About

View the firmware version.

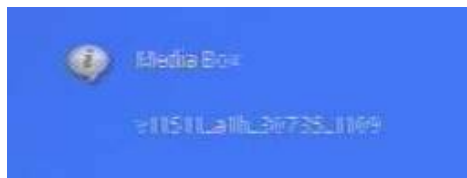

8. TROUBLESHOOTING

Situation	Check Point
No Picture	<ol style="list-style-type: none"><li data-bbox="381 288 857 312">1. Check power cable and power switches.<li data-bbox="381 336 953 408">2. Ensure the video cable is connected between the B1080Play and TV.<li data-bbox="381 432 1001 504">3. Make sure the file format on the memory card or USB flash driver is correct.<li data-bbox="381 528 958 600">4. Check if your display device is switched to correct video input source.
No Response From the Remote Control	<ol style="list-style-type: none"><li data-bbox="381 628 997 700">1. Ensure that the battery (CR2025 3v lithium battery) in the remote control and it is inserted the correctly.<li data-bbox="381 724 1001 796">2. Check for any barrier between the remote control and B1080Play.
No sound	<ol style="list-style-type: none"><li data-bbox="381 823 771 847">1. Check if the mute function is on.<li data-bbox="381 871 801 895">2. Check if the volume is set properly.<li data-bbox="381 919 969 943">3. Check if audio cable has been connected correctly.